

- Before assembling the trolley, this manual should be thoroughly read.
- This manual should be surely handed over to the users.
- The users of the electric trolley should thoroughly read this manual.

**3 -PHASE ELECTRIC TROLLEY  
MODELS MAF, MAS & MB (Type)  
OPERATION MANUAL (No. 2 )**

- Thank you for your purchase of our product.
- It is quite important that you carefully read this operation manual before using our product.
- This manual should be kept close to the unit concerned, as the maintenance and inspection works absolutely require it.
- Please consult distributors of our products about the inspection requiring dismantling and assembling of the unit.
- For proper operation of the unit, please carefully read also the operation manual of the electric chain hoist.



**ELEPHANT CHAIN BLOCK CO.,LTD.**



**Osaka JAPAN**

## I) SAFE OPERATING PRACTICES

Improper operation of the electric trolley will possibly cause a dangerous situation such as falling of lifted loads, electric shock and so on. Carefully read this manual for proper operation before setting-up, installation, operation, maintenance and inspection of the electric trolley.

Do not begin to operate it before you have got familiar with its knowledge, safety information and all the special cares.

The cautions in handling the unit are classified into two levels in this manual;

|   |   |
|---|---|
| <br><b>WARNING</b> | This symbol is used to indicate that a death or serious injuries will be caused in all probability to the user or persons around when the products are improperly used. |
| <br><b>CAUTION</b> | This symbol is used to indicate that damage may be caused to the user or persons around or only material loss will occur when the products are improperly used.         |

Even the matters indicated  "Caution" may bring a serious result depending on the situation. Strictly observe both the notices as they contain very important matters.

Examples of the symbol:



  $\Delta$ -mark indicates that there are warning/cautious matters. In a sketch a concrete warning ("caution for electric shock" in case of the symbol on the left) is described.

  $\circ$ -mark indicates actions to be prohibited. In a sketch or nearby a concrete warning is described.





  $\bullet$ -mark indicates that any action will be required or directed. In a sketch a concrete warning ("request for connecting an earth" in the case of the symbol on the left) is described.

※The manual must be kept in place where the operator can read it whenever he needs.



### 1 . General

| <b>WARNING</b>  |  |
|---|--|
| <ul style="list-style-type: none"> <li>● The unit should be operated only by those who are familiar with the manual and contents of the instructing plate.</li> <li>● The unit should be operated only by those who are formally qualified having completed training for operation of the crane, handling of the lifting slings, etc. according to the regulations in your country. The employer should kept unauthorized persons from operating the unit.</li> </ul> |  |
| <ul style="list-style-type: none"> <li>● The operation manual of the electric chain hoist should be also read.</li> <li>● Inspection before operation and periodic inspection must be by all means carried out.</li> </ul>  |  |

## 2. Installation and Setting-up

|  <b>WARNING</b>   |   |
|--|---|
| <ul style="list-style-type: none"> <li>● The installation work should be performed only by the specialized contractor or experienced technician.</li> <li>● The electric trolley should not be installed in a place deviated from the provision where it is, for example, exposed to rain or water.</li> </ul> |  |
| <ul style="list-style-type: none"> <li>● Carry out an earth connection. Furthermore, an earth-leakage circuit breaker should be fitted to the electric line.</li> </ul>  |  |
| <ul style="list-style-type: none"> <li>● Attach a stopper to the ends of the traverse and travel rails.</li> <li>● Make sure that a location on which the electric trolley is installed has a sufficient strength.</li> </ul>  |  |

## 3. Operation and Handling

|  <b>WARNING</b>   |   |
|--|---|
| <ul style="list-style-type: none"> <li>● Do not lift loads which exceed the rated load. <ul style="list-style-type: none"> <li>※The rated load is indicated on the nameplate of the electric trolley body.</li> </ul> </li> <li>● Do not get on a suspended load and do not use the electric trolley to lift, support or transport persons.</li> <li>● Do not operate the electric trolley when somebody stays in an area where a suspended load is moved.</li> <li>● Do not move a load over persons.</li> <li>● Do not leave a suspended load unattended.</li> <li>● Do not allow your attention to be diverted from operating the electric trolley.</li> <li>● Do not use the electric trolley for the oblique pulling. <ul style="list-style-type: none"> <li>※First move the electric trolley to right over a load and then lift it.</li> </ul> </li> <li>● Do not use the electric trolley for the earth lifting (for example, lifting objects fixed under the ground).</li> <li>● Do not carry out turnover of a suspended load. <ul style="list-style-type: none"> <li>※Turnover should be done by means of a device specialized in that purpose (Such a turning device is available from us).</li> </ul> </li> <li>● Make sure before operation that the push-buttons properly function. <ul style="list-style-type: none"> <li>Do not operate the electric trolley when the push-buttons are in disorder.</li> </ul> </li> <li>● Immediately stop operating the electric trolley when it moves in other direction as commanded by the push-button switch.</li> <li>● Make sure before operating the electric trolley that the brake properly functions.</li> <li>● Do not operate the electric trolley when the brake is in disorder.</li> <li>● Do not use an electric trolley which was damaged or causes abnormal sound and/or vibration.</li> <li>● The traversing rail must be grounded.</li> </ul> |    |
|  |  |

## CAUTION

- Do not use the electric trolley at voltages other than the rated voltage in your country.
  - Do not operate the electric trolley by plugging (abrupt reversing) or frequent inching.
  - Do not have the suspended load caught on other structures or cables.
  - Do not have the push-button cord caught on other structures, or do not pull it strongly.
  - Do not have the electric chain hoist or the trolley hit against stoppers or other structures.
  - Never use the electric trolley at a load time rate and with a starting frequency exceeding the rated values.
  - Do not use the electric trolley with name plates and labels attached to the body removed or left unclear.
- Always keep the push-button kit clean so that dust, sands and the like will not be deposited on it.
  - In the case of double electric trolleying, two electric trolleys should be operated in a synchronized manner.



## 4. Maintenance, Inspection and Modification

### WARNING

- Never make modifications to the electric trolley and its accessories.
  - Never use parts other than genuine ones made by us.
- Before carrying out the maintenance, inspection or repair do not fail to turn the power source off.
  - Only specialists authorized by the employer may carry out the maintenance, inspection or repair.
  - Carry out the maintenance, inspection or repair with the electric trolley unloaded (e.g. without loads).
  - When any disorder is found in the maintenance or inspection, immediately make repair before re-operating the electric trolley.



### CAUTION

- Whenever carrying out the maintenance, inspection or repair, set up a warning plate indicating “Under working” (“Under Inspection” or “Passing the current prohibited”, etc.).



Notice:

- Inspections requiring dismantling and assembling of the unit should be carried out by dealers of our products.

## SPECIFICATION

Table 1

| Rated load        |                 | 250kg-2ton   | 2.5ton-5ton     | 7.5ton & 10ton      |
|-------------------|-----------------|--|-----------------|---------------------|
| Motor output      | MAF & MAS types | 0.4kW  | 0.75kW          | 0.75kW × 2          |
|                   | MB type         | 0.1kW : 0.4kW  | 0.19kW : 0.75kW | 0.19kW : 0.75kW × 2 |
| Insulation        |                 | E-class  |                 |                     |
| Time rated        |                 | MAF & MAS types : 30 minutes MB type : 15/30 minutes |                 |                     |
| Operating voltage |                 | 24 V   |                 |                     |

## INSTALLATION AND SETTING-UP

### WARNING

- Refrain from installing the electric trolley by yourself and leave the installation work to the care of a specialized contractor.
- ※ Otherwise you might be wounded by electric shock or the electric trolley fallen.
- Do not fail to conduct an earthing. Furthermore, a leakage circuit breaker should be installed in the electric path.
- ※ Conduct earthing and fitting of the said breaker in accordance with regulations valid in your country.
- ※ Above measures are absolutely necessary for avoiding an accident by electric shock.



Concerning the installation, consult us or a distributor of our products.

### Electric wiring

- Leave the electrical work to the care of a specialized contractor, who should properly carry out the work observing this instruction manual.
- Carry out the electrical work in accordance with the technical standards on the electrical equipment and regulations for the internal wiring in your country.
- Before connecting the power source to the electric trolley, make sure whether its voltage complies with the applicable source for the electric trolley.
- Connecting the power cable

### Earthing and fitting of the leakage circuit breaker

### CAUTION

- Do not fail to conduct an earthing. Furthermore, a leakage circuit breaker should be installed in the electric path.
- The power source must be connected via the switch cabinet (main circuit breaker).
- When the electric trolley is not used, the switch cabinet should be cut off for preventing risks.

## CAUTIONS ON INSTALLATION

Use the electric trolley, paying attention to the following ;

### CAUTION

- Never use the unit in an atmosphere laden with explosive gases. Otherwise a fire may be caused by electric sparks.
  - Never lift loads exceeding the rated load.
  - ※ Otherwise the chain hoist may be damaged or loads may fall down, as is quite dangerous.
  - Never work by pulling of loads.
  - ※ Otherwise the side-plate of the trolley may open, leading to its falling down. Even though the trolley may not fall down, the electric chain hoist may be disordered.
- 
- For both preventing and detecting leakage, a leakage circuit-breaker must be installed.
  - ※ The installation should be carried out by contractors authorized by electric companies or by a servicing agent authorized by the manufacturer.
  - The traveling rail has to be earthed. For better conductivity, the faces of the traveling rail and wheels must be free from paint, oil, dust etc.
  - For power supply, use the supply cables with capacity specified by the manufacturer (Refer to the operation manual of the electric chain hoist).
  - ※ Pay a special attention to the power supply when the unit is used far away from the power source by making use of extended cords and the like, because the unit may not be able to normally operate due to the voltage drop and furthermore the unit or the extended cords may be burnt due to heating-up caused by the reduced torque.
  - The leakage may be caused depending on conditions of a place where the unit is used.
  - ※ Do not use the unit in a steamy atmosphere or outdoors in rain.
  - Use the unit in a range of the time rated.
  - ※ Operating the unit exceeding the time rated may cause the motor to be rapidly heated, resulting in burning of the motor and electrical parts.

## HOW TO CONNECT THE 3-PHASE ELECTRIC CHAIN HOIST WITH THE 3-PHASE ELECTRIC TROLLEY

- The 3-phase electric trolley can be used by directly connecting the 3-phase electric chain hoist or suspending it.

## HOW TO CONNECT L-TYPE CHAIN HOIST WITH THE TROLLEY



### WARNING

- Fit all the connecting fixtures without fail and properly make the connection; otherwise, the trolley and loads may fall down, as is quite dangerous.
- ※ Properly assemble the electric trolley and the trolley.



### 1. Direct connection for 0.5 ton and 1 ton types (common to electric, geared and plain trolleys)

- (1) Remove the motor cover of the electric trolley. (The motor cover is fixed by 4 bolts with washers.)
- (2) Remove the top hook pin by pulling it out.
- (3) Take the connecting fixture out of the trolley and attach it to the top hook pin of the electric trolley.
- (4) In the case of attaching the connecting fixture without dismantling the trolley, it is convenient for the connecting work to take the locking pin and the collar for the locking pin out of the body of the electric trolley and to attach them to the top hook pin of the electric trolley (for 0.5 ton and 1 ton only).  
(When the reinforcing bush fell out, it has to be again attached to the side plate on the gear side. The locking pin and the collar for the locking pin taken out of the body should be surely re-fitted to their original positions.)
- (5) Attach the motor cover to its original position.
- (6) Finally assemble all the components except the top hook to complete the connection work.

### 2. Direct connection for 2 ton type (common to electric, geared and plain trolleys)

- (1) First remove the split pin with a hexagonal nut for the connecting bolt of the electric chain hoist and then remove the top hook by pulling the said bolt out.
- (2) Mount the connecting fixture for the trolley onto the connecting bolt of the electric chain hoist and lock the nut to fit the split pin to the plate.

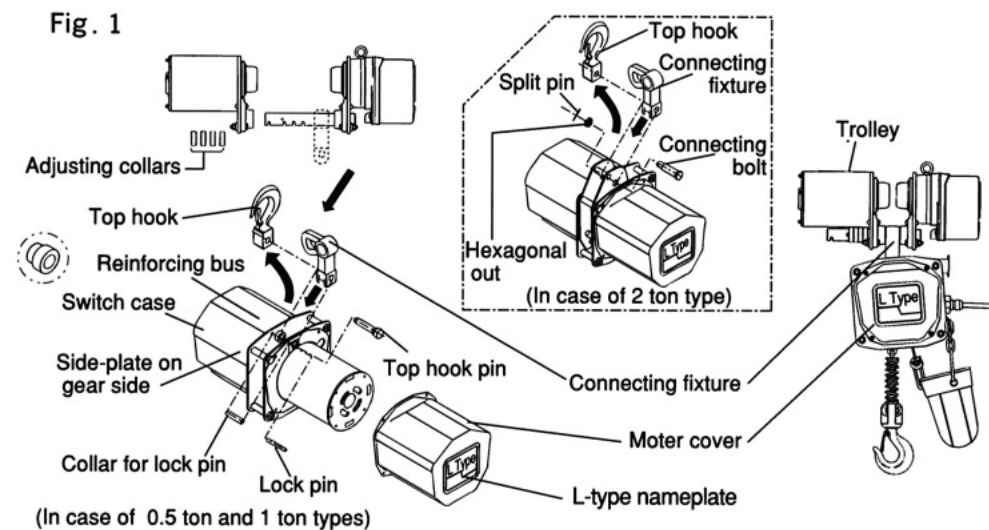

## HOW TO MOUNT THE ELECTRIC CHAIN HOIST CONNECTED WITH ELECTRIC TROLLEY ONTO THE RAIL

### WARNING

- Fit all the connecting fixtures without fail and properly make the connection; otherwise, the trolley and loads may fall down, as is quite dangerous.
- ※ Setting with the key-plate fitted to (a) should be regarded temporary only and the trolley may fall when the electric trolley is used in such a setting. Never operate the assembly or leave it in such a setting.
- ※ When adjusting the width by adjusting collars, be sure to insert them equally on either side of the connecting fixture. Inserting the collars together on one side only may unevenly load the trolley, causing an accident of its falling down.

#### ● How to mount the electric trolley onto the rail

- (1) After completion of the connecting work of the electric trolley and the trolley, adjust the rail width of the trolley by using adjusting collars. (Mounting work can be easily done by means of a unique suspension shaft of our make, that is, by lifting the assembly with the side-plate on the motor side temporarily fitted to (a).)
- (2) Lift the assembly by an electric trolley and the like by slinging the eyebolt fitted to the trolley.
- (3) Mount onto the rail tread the wheels first on the side of the electrical components box and then those on the motor side after removing the key-plate temporarily fitted to (a). (Be careful when removing the key-plate that the motor side should not slip down.)
- (4) Firmly refit all the bolts and nuts loosed to their former positions.

Fig. 2

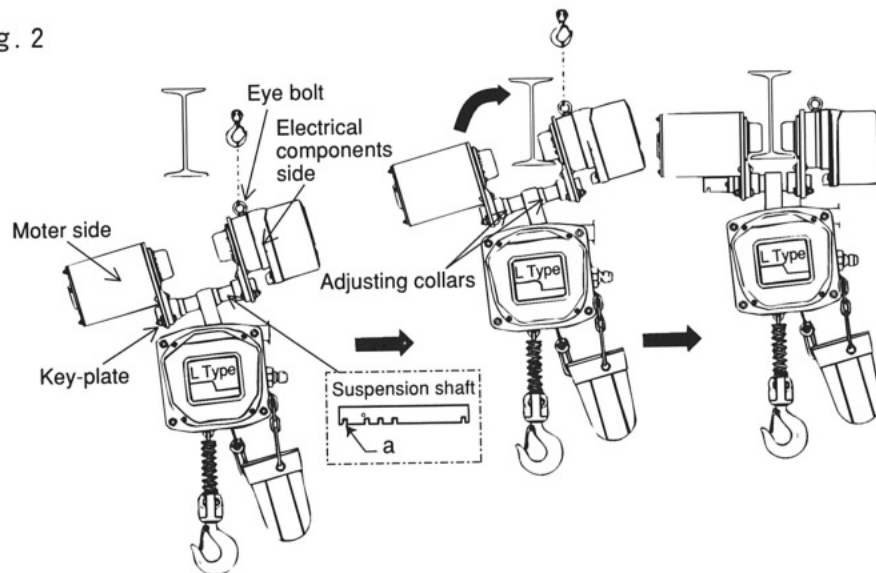

## CONNECTING THE ELECTRIC CHAIN HOISTS TYPES FA & FB TO THE TROLLEY

- In cases of both direct and hanging connections, the electrical components of the trolley should be on the side of the chain bucket of the electric chain hoist.

Fig. 3 DIRECT CONNECTION

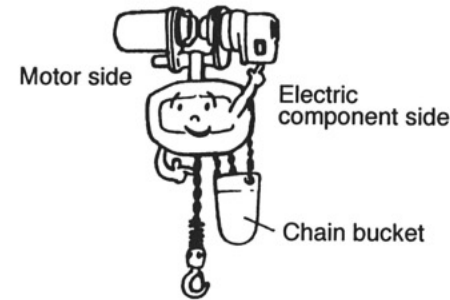
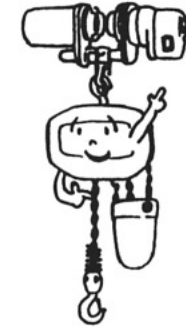

Fig. 4 HANGING



### WARNING

- Fit the round fixtures connecting the electric trolley without fail and properly make the connection; otherwise, the trolley and loads may fall down, as is quite dangerous.
- ※ Properly assemble the electric trolley and the trolley.

- In case of the direct connection, remove once the top hook pin to remove the top hook and instead fit the connecting fixture on the trolley to the electric chain hoist to fix it with the top hook pin.
- Remove the cover on which the rated load is indicated (fixed with 4 spring-washer bolts) and pull out the black top hook pin to remove the top hook. Not only the top hook but also 2 plated round fixtures are mounted on the top hook pin. These 2 fixtures must be again refitted, having set a connecting fixture of the trolley instead of the top hook.; otherwise, the electric chain hoist may fall down, as is quite dangerous. Careful and proper assembling is required. When all the components except the hook are reassembled, the direct connection is finished.

Fig. 5

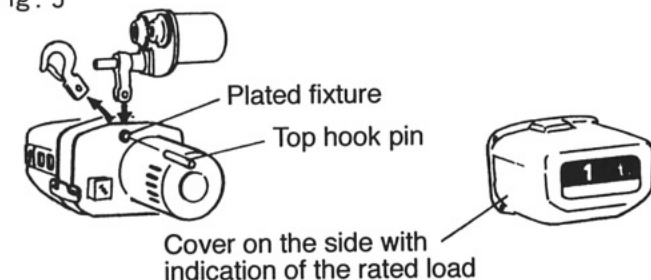

## HOW TO ADJUST THE TROLLEY TO THE RAIL WIDTH

The key slot "a" among those on the suspension shaft of the trolley is made to enable the fitting to be easily carried out and it is possible to expand the side-plate distance by temporary setting of the key-plate at the slot "a" as the sketches on the left side in Table 2 to make fitting from the underside (Do not forget to insert the same number of pieces of adjusting collars on both sides of the connecting fixture).

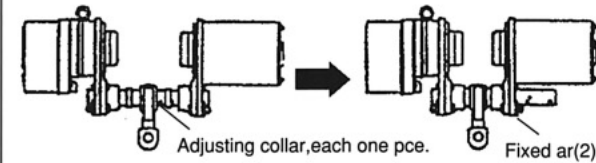
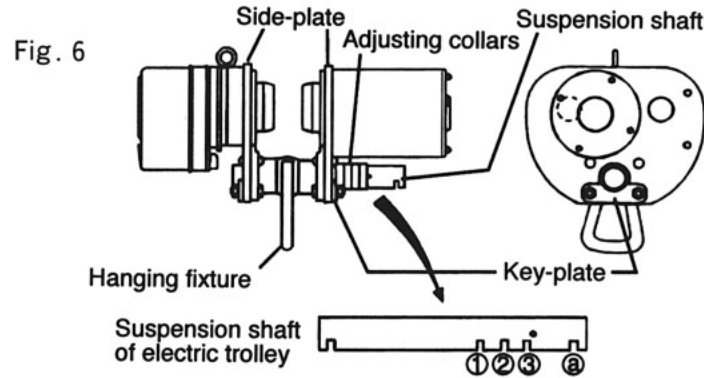

For 0.25t~1t: Rail width 100mm  
For 1.5t~3t: Rail width 125mm  
For 4.8t~10t: Rail width 150mm  
Each one adjusting collar on both sides of the connecting fixture

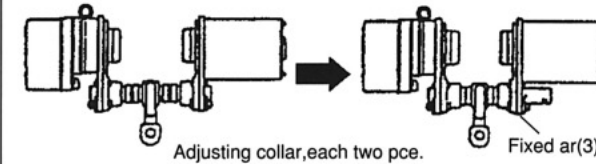

For 0.25t~1t: Rail width 125mm  
For 1.5t~3t: Rail width 150mm  
For 4.8t~10t: Rail width 175mm  
Each two adjusting collars on both sides of the connecting fixture

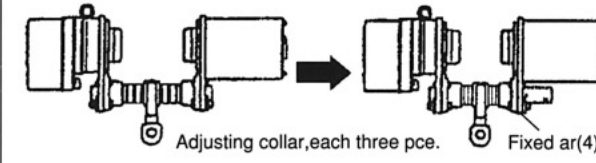

For 0.25t~1t: Rail width 150mm.  
Each three adjusting collars on both sides of the connecting fixture  
For 4.8t~10t: Rail width 190mm  
Each three adjusting collars, that is, 2 thick and 1 thin on both sides of the connecting fixture (6pcs. in total)

## ⚠ WARNING

- Setting with the key-plate fitted to "a" should be temporary only and the trolley may fall when the unit is used in such a setting. Never operate or leave it in such a setting.
- Insert the same number of pieces of adjusting collars on both sides of the connecting fixture. If they are inserted on one side only, a load is not uniformly applied, causing a dangerous situation such as abnormal movement of the trolley or its falling, etc.

Table 2

With the key-plate temporary fixed at "a" (operation impossible in this setting)



With the key-plate finally fixed at (1), (2), (3) or (4)

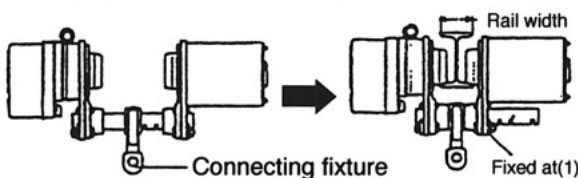

For 0.25t~1t: Rail width 75mm  
For 1.5t~3t: Rail width 100mm  
For 4.8t~10t: Rail width 125mm

## WIRING

### ● 4-point push-buttons

- (1) Connect the two cables from the 3-phase electric trolley (cables with 4-point and 6-point plug respectively) to the electric chain hoist. As to the fitting of the connectors, refer to the operation manual included in the package of the push-button cord.
- (2) Connect the push-button cord (with 15-point plug) to the electric trolley.
- (3) Connect the power cable to the power source to complete the wiring (standard length of the power cable: 0.5m). To extend the power cable, remove the cover for the electrical components and properly attach a crimp-style terminal to a power cable with a required length (with 4 core wires).

### ● 4-point push-buttons (Connecting to the types DA & DB)

- (1) When the electric trolley and the electric chain hoist are together purchased, they will be delivered with the internal wiring completed.
- (2) When the electric trolley is separately purchased, refer to the wiring diagram included in the operation manuals of the types DA & DB or consult a dealer of our products.

### ● Fit the push-button cord as shown in the following sketch:

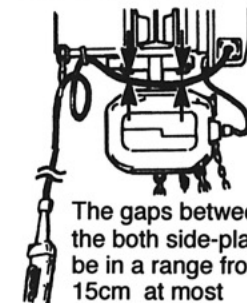
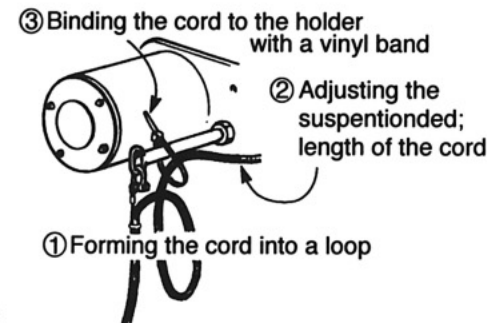
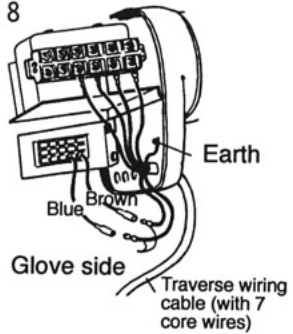

Fig. 7

● 6-point push-buttons

Fig. 8



Covered crimp-style terminal:  
Properly crimp it by a crimping tool commercially available (which is not included in the standard set)  
Connecting steps other than 7 core wires are same as with 4-point push-buttons.

- (1) Remove the case for the electrical components for the electric trolley to remove the power cable.
- (2) Instead prepare a traversing wiring cable (with 7 core wires) with a required length and connect its 4 core wires by means of crimp-style terminals to the position where the power cable removed as per the paragraph (1) is connected. The 2 wires out of 3 core wires are to be connected to the shorter wires in brown and in blue respectively connected to the socket of the trolley. Make connection by using a covered crimp-style terminal of which plug is inserted into the female side. Connect one remaining core-wire to the terminal connecting the black wire from the socket by using a crimp-style terminal. Connections to gray and purple wires are not necessary.
- (3) Assemble the case for the electrical components as before.

- (4) Connect the cables from the electric trolley (cables with 4-point and 6-point plug respectively) to the electric chain hoist. As to the fitting of the connectors, refer to the operation manual of the push-buttons.
- (5) Connect the push-button cord (with 15-point plug) to the electric trolley.
- (6) Four wires connected as per the paragraph (2) out of 7 core wires are for power supply and earth, and remaining 3 wires for operation (The wire connected to the black wire is common).

As to the control of the saddles, refer to the operation manual of the switch box for the saddles, model SBA. When the power source is put on after completion of the wiring and the push-button is pressed, it may happen that the traversing (trolley) is possible but the lifting/lowering (chain hoist) is not possible. It means that the the negative-phase prevention mechanism for the chain hoist is actuated. In this case, exchange 2 wires each other out of 3 wires except the earth wire in the power source box connecting the power cable (Refer to also the operation manual of the electric chain hoist).

**OPERATIONAL CAUTIONS**

|                    |   |
|--------------------|---|
| <br><b>WARNING</b> | <ul style="list-style-type: none"> <li>● Avoid sudden reverse operation (plugging) by push-buttons.</li> <li>※ Such an operation causes a great instantaneous load exceeding double the lifted load, shortening the lifetime of the body and the chains.</li> </ul> |
|--------------------|---|

● Avoid an inching operation.

The inching may badly affect the mechanical lifetime and shorten the lifetime of connecting elements, electrical parts, motors and the like. Furthermore, the inching may cause the lifted load to be swung, as may lead to a big accident. Neither inching nor plugging operation should be allowed.

**CAUTIONS ON INSTALLING THE ELECTRIC TROLLEY**

**⚠ WARNING**

- When adjusting the width, be sure to insert the adjusting collars equally on either side of the connecting fixture. Inserting the collars together on one side only may unevenly load the trolley, causing an accident of its malfunction or falling down.



**1 How to fit the trolley to the traversing rail**

- The trolley can be fitted to the rail, being adjusted to several different widths of the traversing rail by shifting adjusting collars only.
- Insert the same number of pieces of adjusting collars on both sides of the suspension (connecting) fixture of the electric trolley.
- Avoid improper setting shown in Fig. 9 (marked with X) which may result in serious accidents

Fig. 9

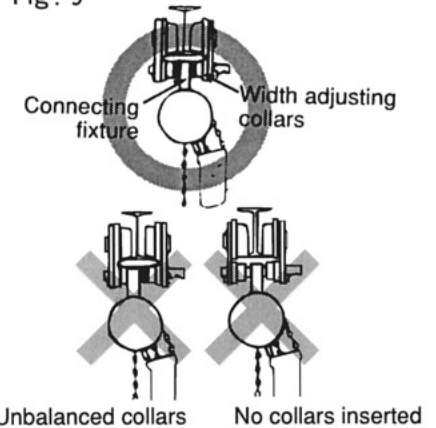

**2 How to fit the trolley to the curved traversing rail**

- (1) In the case that the electric trolley or the electric trolley with a geared trolley is fitted to the curved traversing rail, its motor or hand chain wheel side should be outside the rail curve.
- (2) If they are inside the rail curve, the traversing rail or the wheel gear of the trolley may be possibly damaged.
- (3) In the case that the traversing rail has curves in both the right and left directions, the trolley should be fitted in such a manner that the above-mentioned instruction applies to a smaller curve (Refer to Fig.10).

Fig.10

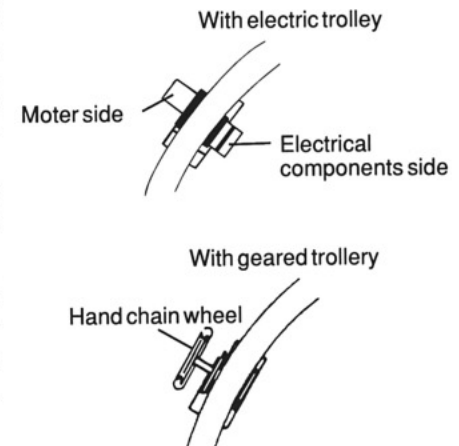

### 3 Traversing rail and stoppers

## ⚠ WARNING

- For avoiding eventual falling of the electric trolley and the trolley, mount a stopper at the rail ends.
- Avoid stopping the trolley by hitting it against a stopper.

A portion of the traversing rail contacting trolley wheels should not be painted but be polished when it is rusted.

#### ● Joints of the traversing rail

- (1) Joints of the traversing rail should be located in the vicinity of supports for the rail.
- (2) In the case that a backing plate is welded on the side or bottom of the rail (See Fig. 11), a plate with suitable thickness must be selected.
  - ※ If too thick a plate is attached, the trolley will hit it and be unable to pass through the point in the worst case.
- (3) Staggered joints must be aligned within 0.5mm in both horizontal and vertical directions. The portions on which the trolley wheels travel should be finished by a grinder (See Fig. 12).

Fig. 11

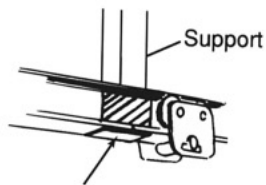

Pay attention to the thickness of backing plates.

Fig. 12

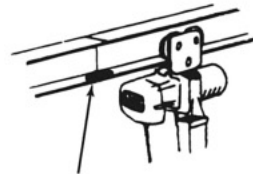
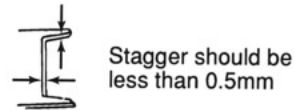

Rail joints should be finished by a grinder.

#### ● Anti-falling stoppers at the rail ends

- (1) For avoiding that the electric trolley will hit a wall, etc. even when it hits the stoppers with a higher speed or the electric trolley swings, a distance (a) shown in Fig. 13 should be sufficiently wide.
  - (2) The stoppers should be firmly secured so as to withstand the impact and be covered with a shock-absorbing material like rubber, etc. (See Table 3).
- ※ Avoid such installation and operation as the trolley always stops by running against the stopper.

Do not pull the push-button cord.

Do not traverse the trolley by pulling the push-button cord (Fig. 14).

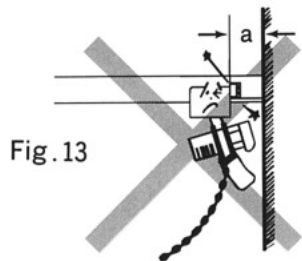

Fig. 13

Undue burden on a cord

Fig. 14



#### ● Stop the trolley before it hits against the stopper.

- (1) On controlling the traversing of the trolley, operate the trolley so as to stop the trolley of itself before it hits against the stopper (Fig. 15).

Fig. 15

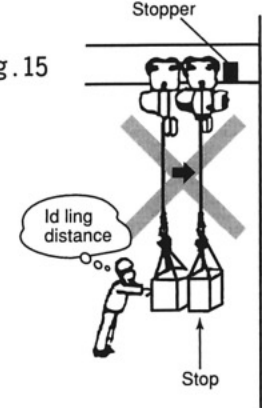

### Table 3 Stoppers

| Dimension of the traversing rail (mm) | 150×75<br>200×100 | 250×125  | 350×150  | 450×175  |
|---------------------------------------|-------------------|----------|----------|----------|
| Angle steels (mm)                     | L50×50×6          | L65×65×6 | L75×75×6 | L90×90×7 |
| A (mm)                                | 20                | 30       | 35       | 45       |
| B (mm)                                | 50                |          |          |          |
| C (mm)                                | M16               |          |          |          |

Fig. 16

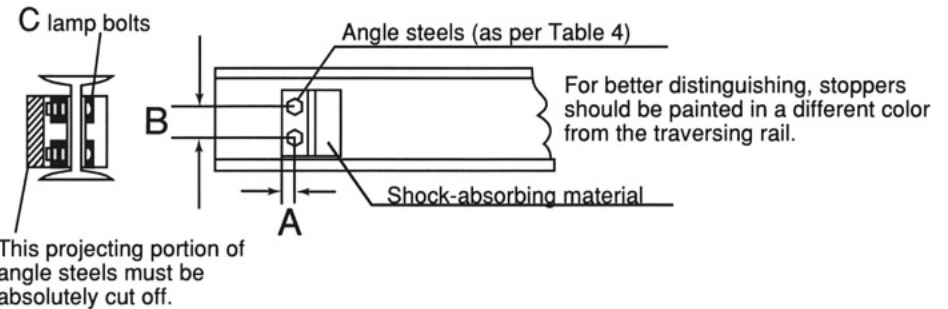

## DAILY INSPECTION

For daily operation, be sure to carry out the following check prior to operation.

- In cases of any abnormality, stop operating the unit and take proper counter-measures before using it again.
- Consult a dealer of our products when it is not possible to take proper measures.
- ※ As to details refer to the operation manual of the electric chain hoist.

## Monthly inspection

- Carry out the voluntary inspection more than once in a month.
- If there is any abnormality discovered by the inspection, take appropriate measures against it.
- ※ As to details refer to the operation manual of the electric chain hoist.



## Annual inspection

- Carry out the voluntary inspection more than once in a year.
  - If there is any abnormality discovered by the inspection, take appropriate measures against it.
- ※As to details refer to the operation manual of the electric chain hoist.

## PROCEDURES FOR MAINTENANCE AND INSPECTION

### WARNING

- Before doing maintenance, inspection and repair work, be sure to switch OFF the power source.
- Maintenance, inspection and repair work should be done by persons with specialized knowledge, or else, you should ask a dealer of our products.
- Make it a rule to carry out maintenance, inspection and repair in non loading (hoisting no loads) condition.
- If any abnormality is found in the maintenance and inspection, do not use the unit.



※As to details refer to the operation manual of the electric chain hoist.

## INSPECTION OF THE TROLLEY AND ITS LIFETIME

### ● Bent side-plates

- Two side-plates should be free from deformation.
- The angle shown in Fig. 17 should be right angle.
- Supply oil if there is abnormal sound caused by lack of oil in making traverse movement.
- There should be no missing or looseness of the bolts, nuts, etc.
- The wheel with gear cut on it should not have dust in the geared portion.

Fig.17

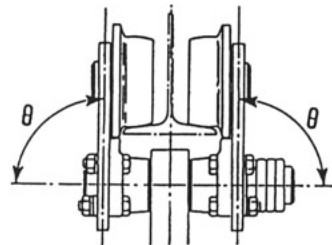

### ● Wear of trolley wheels

Trolley wheel as described below should be replaced with new one.

Fig.18

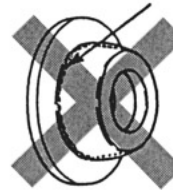

There is such a visible, obvious gap in the portion which is in contact with the edge of I-beam.

Fig.19

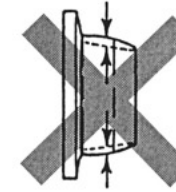

The wheel gets more than 5% wear-out from the original configuration.

Fig.20

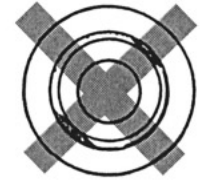

The wheel having partial wear on the tread surface (visible degree).

Fig.21

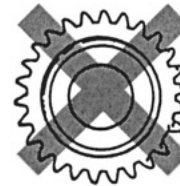

The gear of geared wheel has been worn out and/or damaged in visible degree.

Fig.22

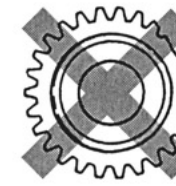

A tooth or some teeth of the geared wheel have been broken off.

## OVERALL OPERATION (to be finally checked)

- Check that the electric trolley moves according to directions from the push-button switch.
- Make sure a distance the trolley travels until it stops, having released the push-button.
- Check that any abnormal sound is not caused in traversing movement.
- Check the gear for greasing and sticking of dust etc. on it.
- Make sure that bolts, nuts etc. at each position are not loose.

# WIRING DIAGRAM

4 -Push button  
MAF-MAS Type

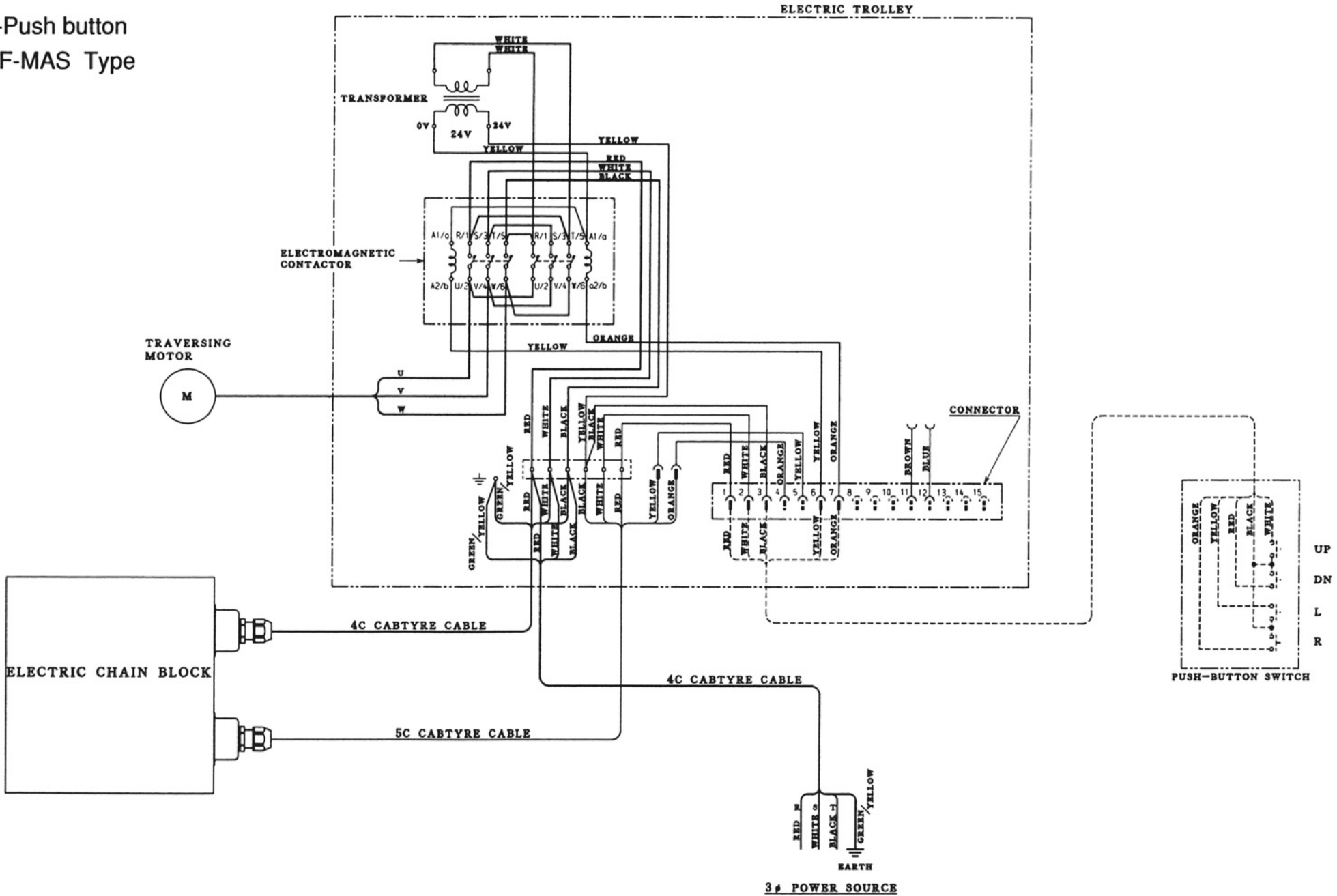

# WIRING DIAGRAM

6 -Push button  
MAF-MAS Type

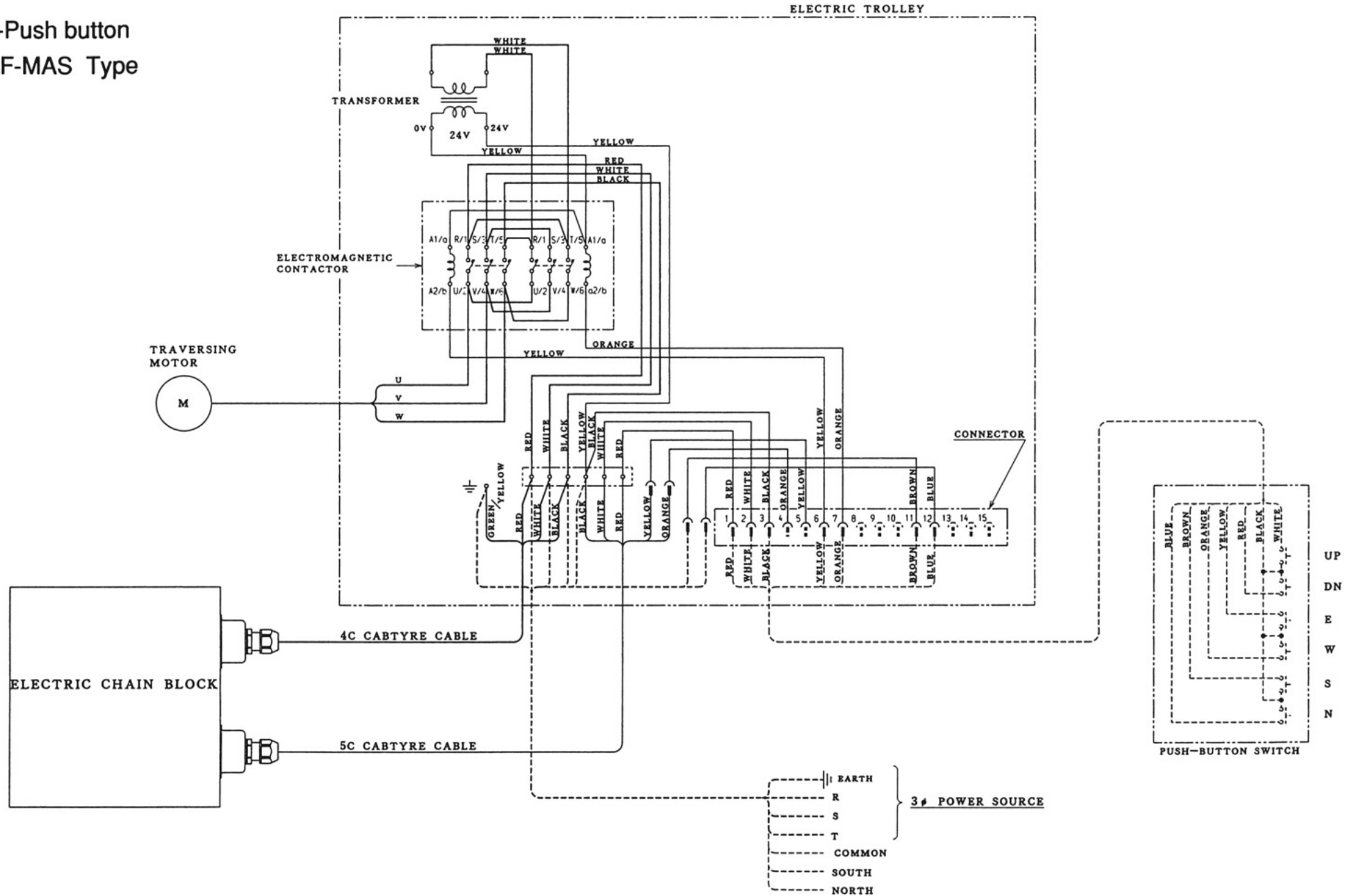

# WIRING DIAGRAM

4 -Push button  
MB Type

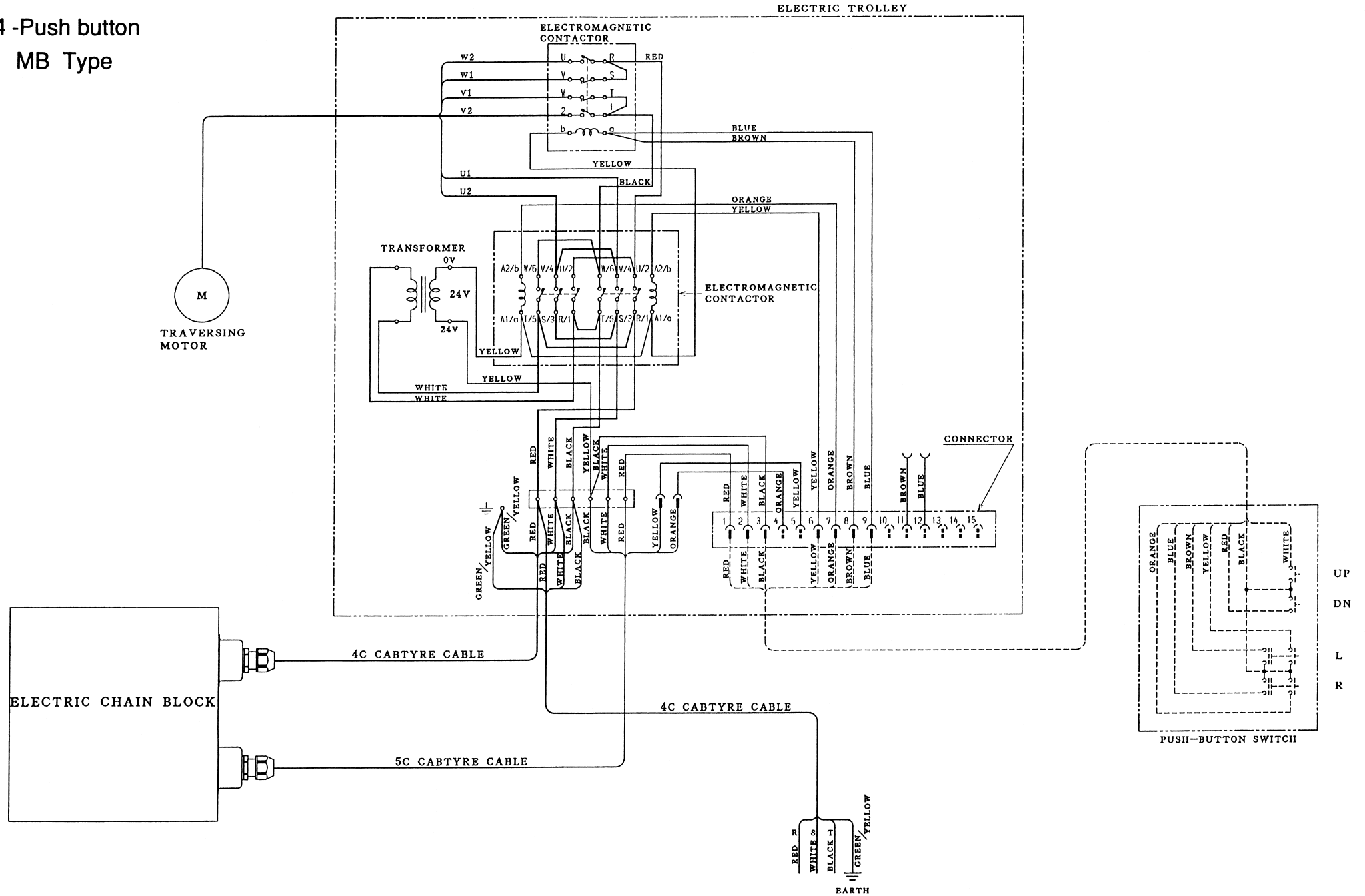

# Electric trolley

● 3-phase (0.5ton · 1ton · 2ton · 3ton · 5ton)

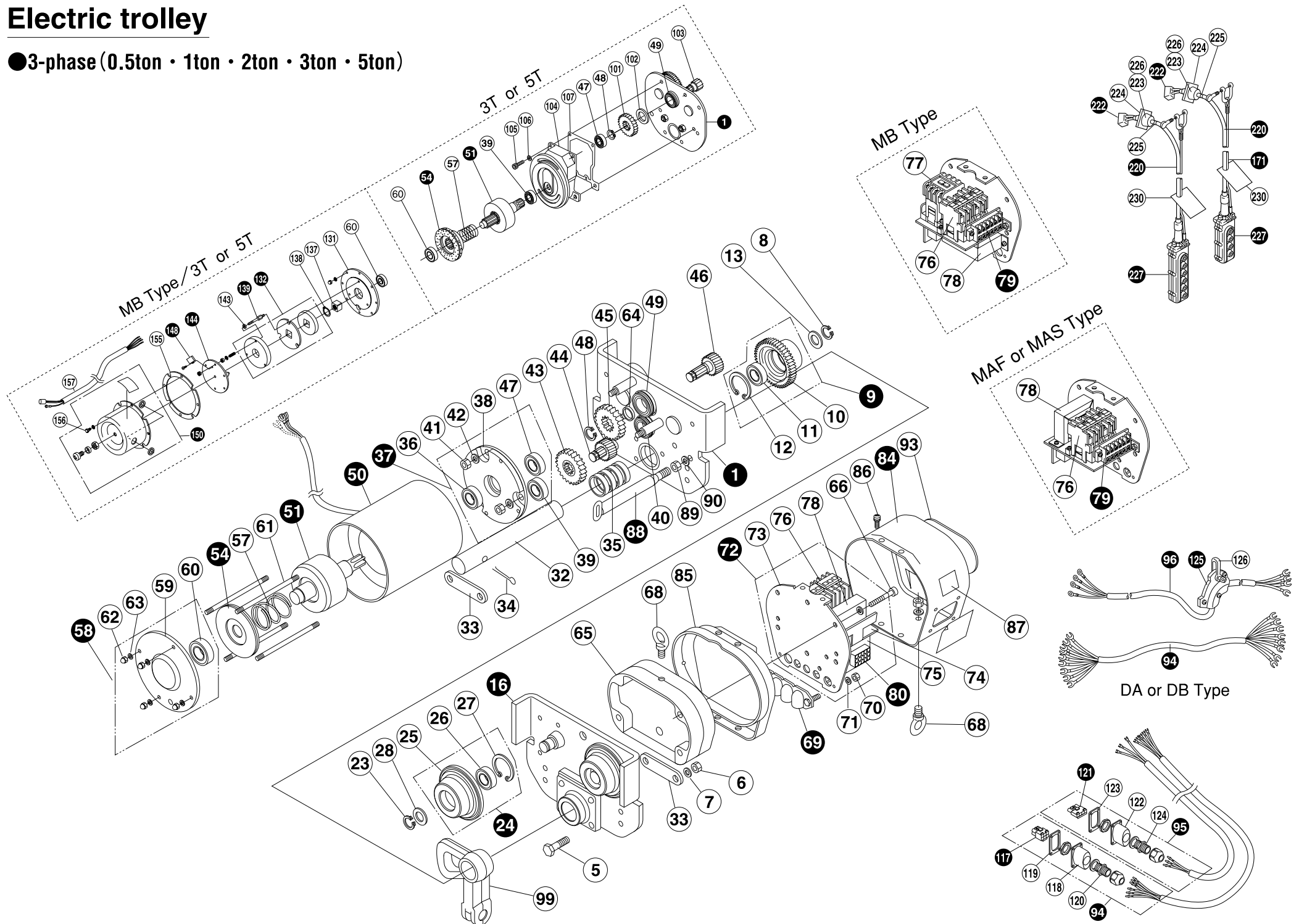

# Electric trolley

## ●3-phase (0.5ton · 1ton · 2ton · 3ton · 5ton)

- ① Gear side plate set
- ⑤ Hex bolt
- ⑥ Hex nut
- ⑦ Spring washer
- ⑧ Snap ring
- ⑨ Gear wheel set
- ⑩ Gear wheel
- ⑪ Ball bearing
- ⑫ Snapping
- ⑬ Washer
- ⑯ Plain side plate set
- ⑳ Snap ring
- ㉑ Plain wheel set
- ㉒ Plain wheel
- ㉓ Ball bearing
- ㉔ Snap ring
- ㉕ Washer
- ㉖ Suspension shaft
- ㉗ Key plate
- ㉘ Cotter pin
- ㉙ Adjust collar
- ㉚ Ball bearing
- ㉛ Flange set
- ㉜ Flange
- ㉝ Ball bearing
- ㉞ Ball bearing
- ㉟ Hex nut
- ㊱ Spring washer
- ㊲ 2rd.gear
- ㊳ 3rd.gear(For low speed)
- ㊴ 4th.gear(For low speed)
- ㊵ 5th.gear
- ㊶ Ball bearing
- ㊷ Snap ring
- ㊸ Ball bearing
- ㊹ Motor case set
- ㊺ Rotor set
- ㊻ Brake drum set
- ㊼ Brake spring
- ㊽ Brake cover set
- ㊾ Brake cover
- ㊿ Ball bearing
- 1 Stay bolt
- 2 Hex cap nut
- 3 Spring washer
- 4 Collar(For 5th. gear)
- 5 Side cover
- 6 Bolt w/hex.hole
- 7 Eye bolt
- 8 Cord holder set
- 9 Hex nut
- 10 Spring washer
- 11 Electric equipment panel set
- 12 Electric equipment panel
- 13 Electric equipment holder
- 14 Socket panel
- 15 Magnetic contactor
- 16 Magnetic contactor
- 17 Transformer
- 18 6P-terminal block set
- 19 Housing socket set  
(pushbutton side)
- 20 Switch case set
- 21 Rubber band
- 22 Screw W/cross hole
- 23 Warning label
- 24 Push button hanger set
- 25 Hex nut
- 26 Spring washer
- 27 Name plate
- 28 Coupling cable set for control
- 29 Coupling cable set for power
- 30 Power cord set
- 31 Connector
- 32 2nd gear
- 33 Washer
- 34 3rd gear(For low speed)
- 35 Gear case
- 36 Bolt W/hex.hole
- 37 Spring washer
- 38 Packing

**The goods has passed rigid inspection by us ahead of delivery in accordance with our standard in terms of test load and all other respects in good and satisfactory condition.**

Inspector *J. Uryu*



**ELEPHANT CHAIN BLOCK CO.,LTD.**

**180 Iwamuro 2-chome, Osaka-Sayama-City,  
Osaka, Postal code 589-8502, JAPAN  
Phone : 072-365-7778 Fax : 072-365-7869**