



- To the dealer: Be sure to hand this instruction manual to the customer.
- To the customer: Be sure to read this manual before using the clamp.

No. 1

Instruction Manual for Elephant WF Series Screw Clamps

- Thank you very much for purchasing a Elephant clamp.
- Before using this clamp, read this instruction manual carefully to ensure that you use it correctly.
- This instruction manual is necessary for maintaining and inspecting the clamp, so please keep it in a safe place.
- Be sure to request your nearest Elephant service shop or our sales office to carry out inspection items which necessitate disassembly and re-assembly of the clamp.

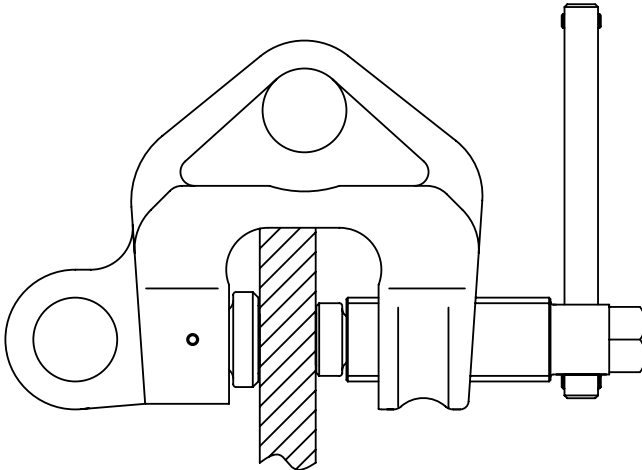

Double cam lock type screw clamp



ELEPHANT CHAIN BLOCK CO.,LTD.

Osaka **JAPAN**



Safety precautions

Be sure to read the following precautions before using the slinging clamp.

If you use the slinging clamp (hereafter called “the clamp”) incorrectly, the suspension load may drop, which is very dangerous. Before using the clamp, be sure to read this manual carefully and use the clamp correctly

Before allowing workers to carry out work using this clamp, ensure that not only the business owner who purchased the clamp but also the workers concerned have received instructions in “Safety Rules for Cranes”, “Slinging Work” in accordance with the regulations of the laws(ordinances, rules, standards) in your country, and also that the workers have adequate knowledge concerning clamps used for slinging work and are also familiar with safety information and precautionary items concerning them.



We classify the precautionary items used in this instruction manual into “Danger” and “Caution.”

 DANGER	A potentially hazardous situation caused by incorrect handling which, if not avoided, may result in death or serious injury
 CAUTION	A potentially hazardous situation caused by incorrect handling which, if not avoided, may result in moderate or light injury, or physical damage

Even an item that is indicated under  **Caution** can potentially bring about a serious result depending upon the particular situation. The contents of both types of precautionary items are important, so be sure to observe them.

● Explanation of symbols



The symbols  and  indicate behavior or an action that is dangerous or requires caution. Concrete precautions are indicated inside the symbols. (The symbol at left urges you to be careful not to get your hand caught.)



This symbol indicates prohibited behavior.



The  symbol indicates an action that the worker is forced or instructed to perform. The concrete instruction is indicated either inside or alongside the symbol. (The symbol at right indicates two-point suspension.)



※After reading this instruction manual, be sure to store it in a place where the user can gain access to it at any time.







1. General Matters Concerning Handling of Clamps

DANGER







- Do not allow a worker who is not familiar with the contents of this instruction manual or the contents of tags and caution nameplates to use clamps.
- NEVER allow a legally unqualified person to carry out crane work or slinging work.
- Do not allow anybody to enter the range in which the suspension load may drop or topple over, while a load is being hoisted or inverted.
- Do not use clamps for any purpose other than slinging work.
- Be sure to inspect clamps before use, and also periodically.









2. Pre-work Check

 DANGER	
<ul style="list-style-type: none">• Do not use clamps that are not suitable for the work method.• Do not use clamps that malfunction or are deformed, cracked, worn or otherwise abnormal.• Do not use clamps to suspend loads made of the following materials: Brittle materials, high hardness materials, low hardness materials, very low strength materials, or members whose grip surfaces are inclined at an angle of 10° or more with respect to each other in the slip-off direction.	
<ul style="list-style-type: none">• Check the type, basic working load, opening dimensions, and periodic inspection “completed” stamp indicated on the body of each clamp.• The magnitude of the suspension load must be within the allowable range of the basic working load of the clamps to be used.• The sheet thickness of the suspension load must be within the allowable range of the clamps to be used.	
 CAUTION	
<ul style="list-style-type: none">• Do not remove tags or caution labels attached to clamps, or use clamps with these indications in an illegible condition.• Do not use clamps under the following environmental conditions: When the temperature of the load to be suspended is more than 150°C or less than -20°C, in a location where there are chemical reagents such as acids or alkalis, or where the atmosphere is acidic or alkaline.	
<ul style="list-style-type: none">• Be sure that the sling to be used with clamps is suitable for the type of slinging work.	





3. Method of Use and Slings Work

 DANGER	
<ul style="list-style-type: none">• Do not use a clamp to suspend a load at one point only.• Do not use clamps to suspend loads in any of the following ways: Two loads clamped together, insertion of an object between the clamps and the load, two loads suspended at different heights, two loads suspended together, or horizontally gripped loads.• Do not use clamps to extract long sheet piles or suspend them in the lengthwise direction.• Do not use clamps when there is a strong wind or when danger is anticipated.• Do not use clamps to suspend the bucket of a backhoe.	
<ul style="list-style-type: none">• Install two or more clamps at positions where balance is maintained, in order to ensure stability of the suspension load.	
<ul style="list-style-type: none">• Ensure that the suspension angle and the attachment width angle of each clamp are within the specified range that matches the type of clamp.• Insert the suspension load to the rear of the open part of the clamp.• When using a clamp with a locking device, be sure to apply the lock.	
 CAUTION	
<ul style="list-style-type: none">• Do not use clamps to suspend a load whose grip surfaces have oil, paint, scale, rust, or other matter adhering to them.• Do not drop or drag clamps along the ground.	

4. Operating a Crane

 DANGER	
<ul style="list-style-type: none">● NEVER suspend a load that exceeds the basic working load of the clamp.● Do not operate a crane that applies an impact load to the suspension load or the clamps.● Do not allow anybody to ride on a load while it is suspended by clamps. NEVER use a crane for an application in which a person rises on the load.● Do not perform earth lifting using clamps.● Do not release the locks of the clamps while hoisting the suspension load.● After disconnecting a clamp from the suspension load, take care that the clamp does not attach itself to the load again or strike an adjacent member.	
<ul style="list-style-type: none">● If a load is applied to the suspension ring when you are hoisting a suspension load with a crane, first stop hoisting the load, and carry out a safety check (insertion depth, locked condition, and so on).● Immediately before the suspension load touches the ground, stop lowering it, and check its tilt, check for toppling, and then check the landing point and the safety in the vicinity.	
 CAUTION	
<ul style="list-style-type: none">● Do not operate the crane in such a way as to drag the suspension load along the ground. Do not leave the operation location of the crane (hoist, etc.) while the load remains suspended by the clamps.	
<ul style="list-style-type: none">● When using a crane to hoist or lower a load, operate it slowly and carefully.	

5. Maintenance and Inspection, Storage and Modification

 DANGER	
<ul style="list-style-type: none">● NEVER modify clamps or accessories.● Do not weld or heat clamps or their accessories● NEVER use clamps or accessories other than genuine ones manufactured by us.● If there are clamps that need to be repaired, store them in a separate place to ensure that they are not inadvertently used.	
<ul style="list-style-type: none">● Maintenance, inspection and repair must be performed only by persons who have specialized knowledge stipulated by the business owner.● If an abnormality is found in a clamp during maintenance or inspection, do not use the clamp in that condition. Either promptly repair it or discard it.● Remove paint, dirt, or other foreign matter from movable parts of the clamp, the cam and the turning jaw.	
 CAUTION	
<ul style="list-style-type: none">● When carrying out maintenance, inspection or repair, be sure that the clamps are not supporting a suspension load.● When carrying out maintenance, inspection or repair, be sure to erect a sign indicating that work is being carried out.● Be sure to lubricate the rotating parts (vicinity of the pin) and also sliding parts (such as the guide grooves) of each clamp.● Be sure to store clamps indoors.	

[Caution] Be sure to request your local dealer or our sales office to carry out the inspection items attendant to disassembly and re-assembly of the clamp in accordance with the inspection standard.

A screw clamp (hereafter called a “clamp”) is a clamp which has been commercialized as a result of the accumulation of many years of research and testing.

We are a top manufacturer of chains, and are also well-acquainted with the steel materials used to make clamps. In the same way as for chains, we employ our unique technology to heat-treat our clamps, thus ensuring steel of the highest possible strength (toughness).

We have also developed a screw with a torque limiter (pat. pending) which prevents the worker from over-tightening it (applying an excessively clamping force to the body) or forgetting to tighten it, thus further increasing the safety of the clamp.

This product can be used safely even by beginners, so we await your orders.

1. Features

- ① The load-acting points on both the screw cap and the cam are hemispherical (pivot-shaped). Consequently, if the suspension load moves by even a minute amount, the clamp will rotate in synchronism with this motion and tilt in the forward direction. This in turn will cause the teeth to cut into the suspension load with a large force. (Refer to Fig. 1.)
- ② Even if the clamp is overloaded to 120%, the cut-in depth will only be about 0.2 to 0.5 mm (differs depending upon the capacity), which is about one half that of a general clamp. Also, the tooth profile is circular, so harmful pressure marks are not left on the suspension load, thus ensuring peace of mind. (Refer to Fig. 2.)
- ③ A fine screw (automatic tightening) is used to apply a tightening force and also prevent the screw from slackening easily. (Refer to Fig. 3.)
- ④ During hoisting work, even in the event that the handle strikes another structural object, causing the screw to work loose (to 60° or less), the holding force of the screw (stroke generated by the tilt of the teeth) will greatly exceed the slackening of the screw, enabling you to use the clamp with peace of mind.
- ⑤ This is the world’s lightest clamp. It can be used even by female workers.
- ⑥ A hemispherical W cam system is employed, causing the clamp to cut into the load from both sides. (Refer to Fig. 1.)
- ⑦ Two suspension holes are provided, enabling the load to be suspended from any direction. (Refer to Fig. 4.)
- ⑧ The head of the screw has a hex hole for a ratchet spanner ($B = 21$). This enables you to install the clamp in a confined space without using the handle. (Refer to Fig. 3.)
- ⑨ You can use the clamp on a load whose grip surfaces are inclined at an angle of less than 10° with respect to each other (8° I-beam). Refer to item 8 of “Precautions for use.”
- ⑩ You can use the clamp instead of an I-plate. (Refer to Fig. 5.)

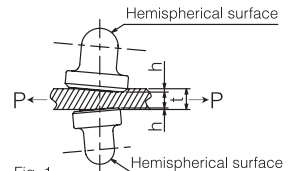

Fig. 1 Depth to which the teeth cut into the load : h



Fig. 2 Tooth profile

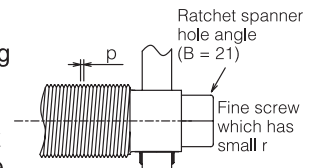

Fig. 3 Pitch : r of screw : p

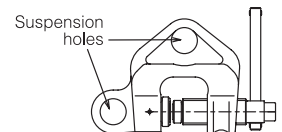

Fig. 4 Suspension holes

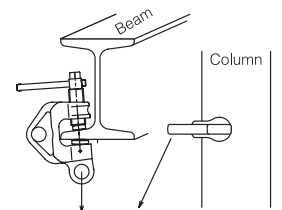

Fig. 5 Example of using the clamp instead of an I-plate

2. Applications

This clamp can be used for hoisting, inverting and conveying steel sheets (intended to be placed on the ground), shaped steel (H-sections, I-beams), pipes, reinforced steel beams, pillars, shipbuilding materials and structures, and also extracting short sheet piles.

3. Pre-work Check

Before commencing the day's work, carry out the following inspections and checks. (Refer to Table 1 for the checking items of various models of clamps.)

- (1) Appearance and function. (damage to the body, operating condition of the screw, rotation and tilt of the screw cap and cam, wear and clogging of the teeth, and so on) Refer to Fig. 1 and item 2 of "Precautions for use."
- (2) Maximum work load indication and minimum working load. (This is 1/10 of the force equivalent to the maximum working load. In the case of a general clamp, it is 1/5.)
- (3) Effective sheet thickness. (Refer to Table 1.)
- (4) Use clamps that are suitable for the mass of the load to be suspended. (Refer to Table 1.)

Table 1

Model	Max working load(t)	Min working load	Effective sheet thickness(mm)
WF-0.5	0.5	0.05	3 - 28
WF-1	1.0	0.1	3 - 40
WF-2	2.0	0.2	3 - 45
WF-3	3.0	0.3	6 - 49
WF-5	5.0	0.5	9 - 53

4. How to Use the Clamps

- (1) Connect the suspension hole in each clamp to a slinging chain sling or wire sling using a coupling or shackle. Refer to item 7 of "Precautions for use." Do not use the suspension hole that causes the clamp to be subjected to an unreasonable force in the direction which tends to prize the clamp open.
- (2) Determine the center of gravity of the load to be suspended, and select (mark) the clamp mounting positions that you consider will enable the load to be suspended stably. Refer to item 1 of "Precautions for use."
- (3) When installing a clamp according to (2) above, gently retain it with one hand, and then turn the handle in the screw-tightening direction to the position where the clamp does not move when you try to move it with your hand. Refer to item 2 of (3) of "Precautions for use."
- (4) Hoist the suspension load to the point where it just leaves the ground, then stop it, check the clamps, and then continue hoisting the load. Refer to items (4) and (5) of "Precautions for use."
- (5) When lowering the suspension load to the ground, select a location such that the load does not topple over.
- (6) When removing a clamp, first confirm that the sling has become adequately slack, then turn the handle in the screw-slackening direction, remove the clamp, and place it on the floor or in the designated position. Refer to item (6) of "Precautions for use."

Table 2 Standard tightening torque (input)

Model	Torque (kgf-cm)	Input (kgf)
WF-0.5	144	12
WF-1	180	15
WF-2	225	15
WF-3	288	18
WF-5	360	20

- Likewise, when you tighten a screw that has a torque limiter, it will turn freely when the specified torque is reached. (Pat. pending)

5. Name of Each Part

Double cam lock type screw clamp

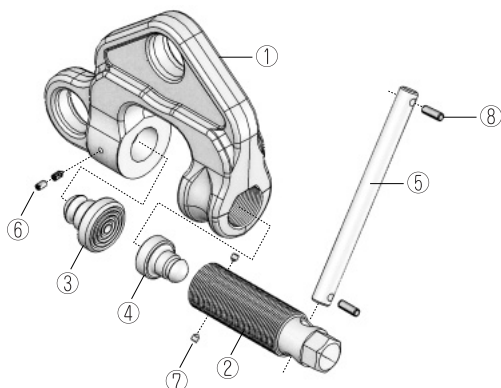

No.	Name of part	Quantity
①	Body	1
②	Screw	1
③	Cam (circular)	1
④	Screw cap (circular cam)	1
⑤	Handle	1
⑥	Setscrew	2×2 locations
⑦	Setscrew	2
⑧	Spring pin	2

6. Precautions for Use

Most accidents involving a clamp are caused by incorrect handling during slinging work or an incorrect working method. Workers must be proficient in the correct method of using clamps, and strive to carry out safe work.

Item	Precautions and explanatory diagrams	Reason
(1) Selection of the hoisting method and installation of the clamps	<p>① Using at least two clamps at pre-marked positions, install the clamps so that they surround the center of gravity of the suspension load.</p> <p>② During this work, strive to ensure that the sling angle between the clamps is no greater than the following angles.</p> <ul style="list-style-type: none"> ● Suspension angle $\alpha \leq 60^\circ$ ● Attachment width angle $\gamma \leq 30^\circ$ <p>Vertical suspension</p>	<p>If the load were to be suspended using a single clamp, it would be liable to set up vibration even the clamp were attached to the center of gravity of the load.</p>

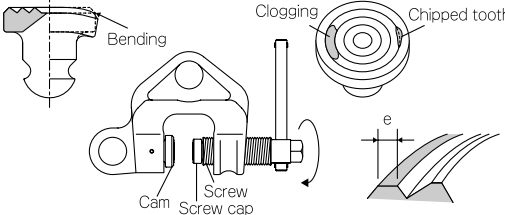
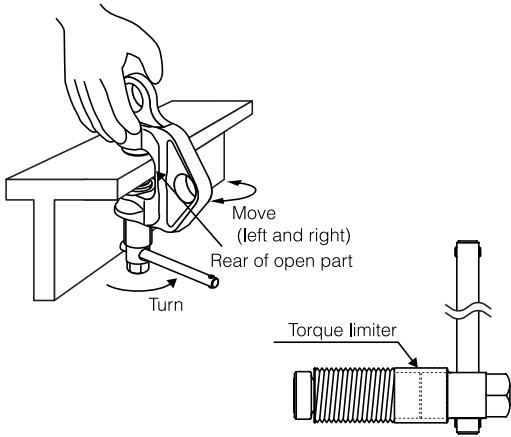
Item	Precautions and explanatory diagrams	Reason
(2) Operation check	<p>① Confirm that the screw, the screw cap and the cam operate smoothly.</p> <p>② Check the teeth to see if they are worn, chipped, bent or clogged. (Refer to the inspection table.)</p> 	<p>If the screw, screw cap or cam does not operate smoothly, the specified tightening force may fail to be attained, causing the suspension load to drop. This may also occur if a tooth is chipped.</p> <ul style="list-style-type: none"> ● Tooth wear width: e <p>Capacity :</p> <p>0.5~1 t e ≤ 0.3mm</p> <p>2~5 t e ≤ 0.5mm</p>
(3) Installing each clamp	<p>① Insert the suspension load to the rear of the open part of the clamp.</p> <p>② When tightening the screw, gently support the clamp with one hand to prevent it from moving, and turn the handle.</p> <p>③ Tighten the screw to the extent that the clamp moves very slightly when you move it left and right.</p> <p>④ If the screw has a torque limiter, turn the screw until it turns freely. (You will hear a 'click' sound.)</p> 	<p>If the suspension load is not inserted a sufficient distance into the clamp, the clamp may slip out, causing the suspension load to drop.</p> <p>Note that if the mass of the suspension load acts on the clamp, a clearance of about 2 to 3 mm may occur between the open part of the clamp and the plate. However, this is due to cut-in of the teeth, not to sliding of the clamp, so there is no need to worry.</p> <p>The torque at which the clamp moves very slightly is the torque indicated in Table 2 of "4. How to Use the Clamps." It is also roughly the same as the maximum torque that can be applied by hand. Even if the clamp is slightly slack, the automatic tightening function of the W cam and stroke resulting from it will prevent the suspension load from dropping.</p> <p>The built-in spring for adjusting the torque performs torque adjustment, and the clamp turns freely when the conditions that set the minimum torque are met. When slackening the screw, you can handle the clamp in the same way as an ordinary product. (Pat. pending)</p> <p>This function prevents the worker from forgetting to tighten the screw.</p>

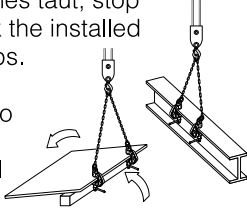
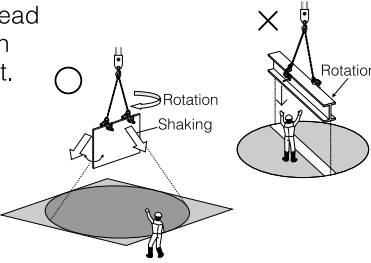
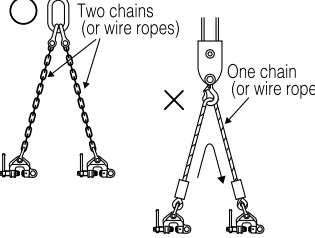
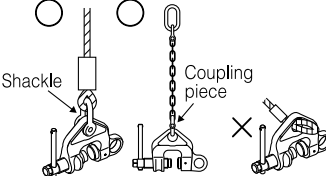
Item	Precautions and explanatory diagrams	Reason
(4) Pulling up, inverting and hoisting a load	<p>① Once the sling becomes taut, stop hoisting it, then check the installed condition of the clamps.</p> <p>② If the load is poorly balanced, causing it to be unstable, interrupt the work and re-install the clamps.</p>  <p>(Pulling up or inverting the load)</p>	<p>The point where the load just leaves the ground means the point at which the suspension load is raised to between 10 and 20 cm above the ground or work floor, and then stopped.</p>
(5) Conveying a load	<p>① Gently move the load so that it does not shake.</p> <p>② Do not pass the load over a worker's head or apply an impact to it.</p>  <p>Rotation Shaking</p>	<p>If a load that was slung using a single suspension clamp is being hoisted, take steps to prevent workers from standing beneath the load.</p> <ul style="list-style-type: none"> ● Beneath a hoisted load means a location directly beneath the load or a location directly beneath the range of shaking or rotation of the load. <p>Within the work range, this may lead to a serious accident depending upon the situation.</p>
(6) Lowering the load, and removing the clamps	<p>① Lower the suspension load gently so that it does not shake.</p> <p>② When lowering the load to the ground, select a stable location and take care that the load does not tilt or topple over.</p> <p>③ To remove each clamp, first confirm that after the load has reached the ground the sling has become adequately slack, then turn the screw in the slackening direction, and when a clearance is formed, grasp the clamp and place it on the floor or a workbench.</p>	<p>Confirm that the vicinity of the load lowering point is safe.</p> <p>If you drop the load, the screw may strike the teeth, causing damage to these parts.</p>
(7) How to connect the clamps to slings	<p>When using two clamps, be sure to use two chain slings or wire ropes.</p>  <p>Two chains (or wire ropes)</p> <p>One chain (or wire rope)</p> <p>Do not connect the chain slings or wire ropes directly to the clamps.</p>  <p>Shackle</p> <p>Coupling piece</p>	<p>Do not connect a single chain sling or wire rope to two clamps. This is because if the sling slips, a greater load than the predicted load will be generated due to the tilt and impact force of the suspension load, which in turn may cause an accident.</p> <p>If the chain sling or wire rope is connected directly to the suspension ring of the clamp, it may become seriously damaged by the corner of the suspension ring.</p>

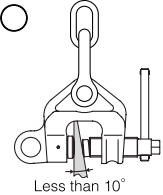
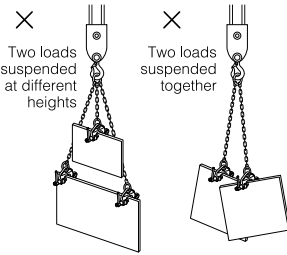
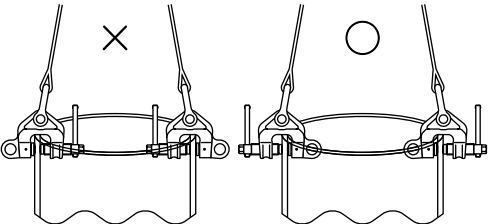
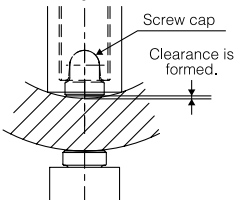
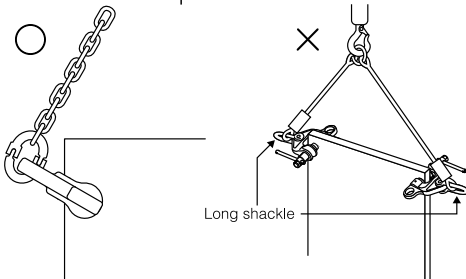
Item	Precautions and explanatory diagrams	Reason
(8) Hoisting a tapered material	<p>Members whose grip surfaces are inclined with respect to each other and are gripped in the slip-off direction may be hoisted provided that the angle of inclination is less than 10°.</p> 	<p>If the position that is gripped by the clamp is inclined in the slip-off direction, and the angle of inclination is large, the screw cap and the cam may fail to cut into the suspension load, resulting in the load slipping.</p>
(9) Hoisting two loads suspended at different heights, and hoisting two loads suspended together	<p>Do not hoist two loads suspended at different heights, or hoist two loads suspended together.</p> 	<p>If two loads are suspended at different heights, the worker will be forced to stand beneath the suspension loads, which is dangerous.</p> <p>If two loads are suspended together, the clamps will touch each other, resulting in possible damage.</p>
(10) Vertically hoisting a steel pipe	<p>When a steel pipe, for example, is to be hoisted vertically, attach the clamp with the screw cap on the outside, as a general rule.</p> 	<p>If you install the clamp with the screw cap on the inside, because of its construction the screw cap may fail to be adequately pushed against the suspension load, preventing the necessary tooth cut-in for hoisting the load from being obtained.</p> 
(11) Horizontal gripping	<p>If you use the clamps in a horizontal gripping condition, be sure to connect each clamp to the load using a coupling, for example, so as to prevent an unreasonable force from being applied to the clamp.</p> 	<p>If you connect the clamp using a long shackle, the bending moment will become large (the lever will increase in length), which may cause the clamp to bend or slip.</p>

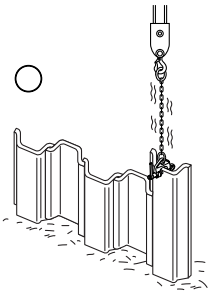
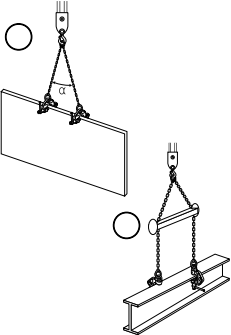
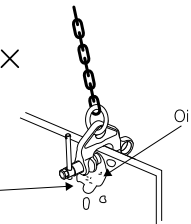
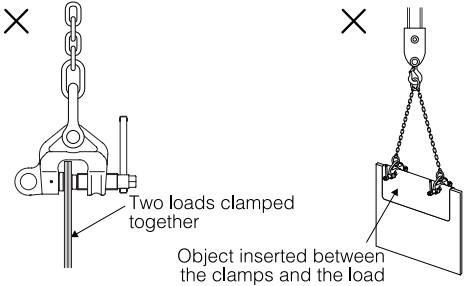
Item	Precautions and explanatory diagrams	Reason
(12) Hoisting a sheet pile, etc.	<p>Be careful when using clamps to extract a sheet pile, for example, because the clamps may be subjected to an overload.</p> 	<p>The end of a sheet pipe is of a complicated shape, so if it is impossible to obtain an adequate grip you must not use clamps.</p> <p>When extracting a sheet pipe, there is a high possibility of the clamp being overloaded by soil pressure, for example, so clamps must only be used to extract short piles.</p>
(13) Low rigidity loads such as long objects	<p>Do not use these clamps to hoist a load that has extremely low rigidity or one that greatly deforms when hoisted.</p> <p>When hoisting a long object, use a balance and install the clamps in a perpendicular condition, or use them within the suspension angle (a).</p> 	<p>When hoisting a load that has low rigidity, there is a danger of the load sagging, causing the clamps to separate from it.</p> <p>If you suspend a long object without using a balance, the suspension angle will increase, causing the installation angle of the clamp to increase as well, which is dangerous.</p>
(14) Hoisting an object that has oil or other matter on it	<p>If there is oil, paint, rust or scale on the grip surface of the suspension load, carefully remove the adhering matter before attaching the clamps.</p> 	<p>If paint, oil or other matter adheres to the screw cap and/or the cam, the teeth are liable to become clogged and the clamps may slip, causing the suspension load to drop.</p>
(15) DO NOT hoist two loads clamped together.	<p>Do not hoist two loads clamped together, or insert an object between the clamps and the load.</p> 	<p>The gripping force of the clamp applied to the suspension load depends upon the cut-in of the teeth. Consequently, if you attempt to hoist two loads clamped together or hoist a load with an object placed between it and the clamps, the teeth will cut into the load on only one side. As a result, there is a danger that the load(s) will slip when subjected to even a very small impact or vibration, causing them to drop off.</p>

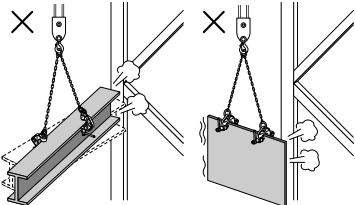
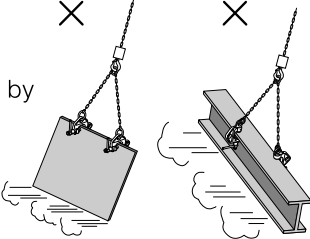
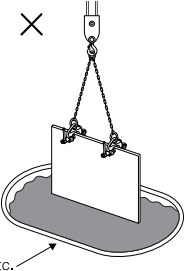
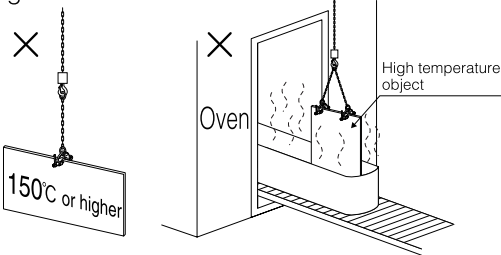
Item	Precautions and explanatory diagrams	Reason
(16) DO NOT allow a load to receive an impact.	<p>Carry out work very carefully so as to ensure that the suspension load or the clamps are not subjected to an impact.</p> 	<p>If the load or the clamps are subjected to an impact, the screw, screw cap, cam and other important parts of the clamps may become damaged, preventing them from functioning properly.</p>
(17) DO NOT drag a load along the ground.	<p>Do not drag the suspension load along the ground while it is grasped by the clamps.</p> 	<p>If you drag the suspension load along the ground, the resulting vibration will momentarily cause a no-load condition to exist. In such a case, the clamping force may decrease or the screw may work loose.</p>
(18) Handling a load that is immersed in a chemical substance	<p>Do not attach a clamp to a load that is immersed in a chemical substance such as an acid or alkali.</p>  <p style="text-align: center;">Acid, alkali, etc.</p>	<p>The body of the clamp or its main parts may corrode, reducing the strength and function of the clamp, and also lead to corrosion cracking.</p>
(19) Working temperature	<p>Do not carry out slinging work on a high temperature object that will cause the temperature of the clamp to become 150°C or higher.</p>  <p style="text-align: center;">High temperature object</p> <p style="text-align: center;">Oven</p> <p style="text-align: center;">150°C or higher</p> <p>If you wish to carry out slinging work in a cold region where the atmospheric temperature is -20°C or below, please consult with us and after we have confirmed that this will not result in a safety issue, please carry out the work in compliance with our instructions.</p>	<p>At a temperature of 150°C or higher, the body, cam and screw cap of the clamp will soften, reducing the strength of the body and also reducing the cut-in force, which in turn may damage the body and cause the load to fall off.</p> <p>At low temperature the impact values of the main part of the clamp are very low, so the strength of the clamp itself will also fall, leading to the danger of the clamp breaking.</p>

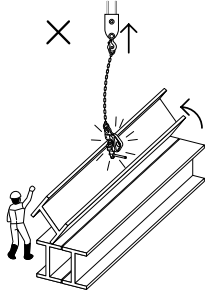
Item	Precautions and explanatory diagrams	Reason
(20) Precautions to observe after removing the clamps	<p data-bbox="210 124 490 320">After disconnecting the clamp from the suspension load, take care that the clamp does not attach itself to the load again or strike an adjacent member.</p> 	<p data-bbox="744 124 1036 405">When the crane cable with the clamp attached to it is wound up after the end of the work, there is a danger of the clamp attaching itself to the clamp again or striking an adjacent member, and causing the load to topple over.</p>
(21) Hardness of the suspension load	<p data-bbox="210 438 688 523">Do not use these clamps to hoist hard steel materials. (Reference value: HB300 and higher)</p>	<p data-bbox="744 438 1024 603">If the hardness of the material is very high, the teeth will fail to cut into it, resulting in positional deviation or slipping, which is dangerous.</p>

7. Maintenance and Storage

After the end of work, it is necessary to clean up the area using the following procedure, and store the clamps in the designated place.

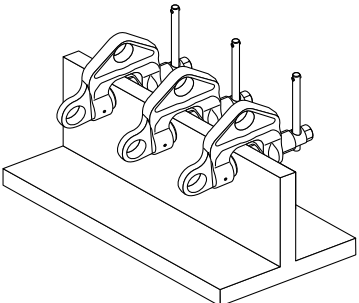
Item	Location to be cleaned up	Cleanup method	Precautions
(1) Removing adhering matter	<ul style="list-style-type: none"> ● Screw: Remove paint, mud, etc. and repair any dents ● Screw cap and cam: Remove paint, mud, etc. 	Using a file, shape any crushed screw threads. Wipe these parts with a cloth. Remove paint, mud, and so on, with a wire brush. Remove dried paint with a chisel, or the like.	
(2) Lubrication	<ul style="list-style-type: none"> ● Screw, screw cap and cam 	Coat these parts with Molykote, and wipe away any oil on the teeth.	If there is oil on the teeth of the screw cap and the cam, the suspension load may slip, which is dangerous.
(3) Storage area	<ul style="list-style-type: none"> ● Screw, screw cap and cam 	Be sure to store the clamps in an indoor location which has a good environment.	<p>If you leave the clamps outdoors or in an environment where the temperature varies greatly, they will rust due to rain or condensation, which may impair their function.</p> <p>If there are clamps that need to be repaired, store them in a separate place to ensure that they are not inadvertently used.</p> <p>If there are clamps that must be discarded, indicate the reason for discarding them on the body, move them to a different location, and discard them quickly.</p>

8. Inspection

1. Kinds of Inspection and Inspection Method

1-1 Daily inspection ... Before starting the day's work, visually inspect the clamps and check their operation.

1-2 Periodic Inspection

① Monthly inspection ... Perform a visual inspection of the exterior and function of the clamps once a month, record the following items, and keep the records for one year.

- (a) Inspection date (b) Inspection results (c) Name of inspector
(d) Required action (Indicate details of any necessary repair or parts replacement.)

② Yearly inspection ... Periodically disassembly and inspect the clamps within once a year, record the following items, and keep the records for three years.

- (a) Inspection date (b) Inspection locations (c) Inspection results (d) Name of inspector
(e) Indicate details of any repair, etc., based on the inspection results
(Shop & sales office, as a general rule).

1-3 Action to Take in the Event of Trouble

If trouble is found in a clamp, prohibit its use, disassemble and inspect it, and either clean or replace the parts, or contact your local service shop or our sales office.

3. Inspection Zone and Judgment Criteria

Table 2 Outline of Inspection of Screw Clamp and Judgment Criteria

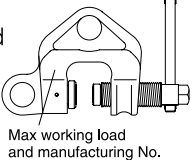
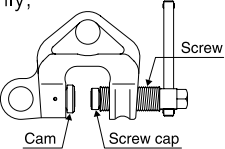
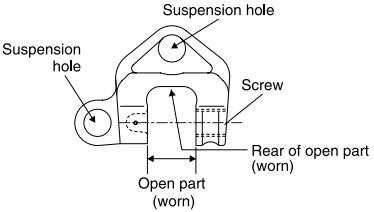
Inspection point	Item	Inspection procedure	Judgment criteria
Appearance	<ul style="list-style-type: none"> ● Clogged or chipped teeth ● Cracks ● Bending ● Rust ● Max working load (The min working load is indicated in the instruction manual.) 	<ul style="list-style-type: none"> ● Visually check the appearance of the clamp. ● If a fault is found as a result of the visual check, disassemble and check the clamp. 	<ul style="list-style-type: none"> ● Do not use a clamp that has clogged or chipped teeth, or is cracked or bent.
	<ul style="list-style-type: none"> ● Arc strike 	<ul style="list-style-type: none"> ● Check for the existence of an arc strike. (Refer to JIS Z3001-2601.) 	<ul style="list-style-type: none"> ● Do not use a clamp that strikes an arc.
Function	<ul style="list-style-type: none"> ● Screw cap and cam ● Screw 	<ul style="list-style-type: none"> ● Check to see if the screw cap and the cam are tilted to the specified angle and also rotate smoothly. ● Confirm that the screw is not bent, deformed, dented, or cracked, and operates smoothly. If it does not operate smoothly, disassemble and check the clamp. 	<ul style="list-style-type: none"> ● Confirm that each part of the clamp operates smoothly.
① Body	<ul style="list-style-type: none"> ● Deformation ● Cracks ● Dents ● Widening of the open part ● Wear of the suspension holes ● Dented or scuffed screw holes 	<ul style="list-style-type: none"> ● Check visually for deformation, cracks, dents, widening of the open part, and wear of the rear. ● Wear of the suspension holes ● Dented or scuffed screw hole ● If the open part has widened, measure it with a vernier caliper ● If you suspect that a clamp is cracked, subject it to a penetrant inspection or a magnetic particle inspection. 	<ul style="list-style-type: none"> ● Do not use a clamp that has any of the following defects: ● A clamp whose open part is significantly deformed, cracked, widened, or worn ● A clamp whose suspension holes are significantly worn ● A clamp whose screw hole is significantly dented or scuffed ● Each tolerance value shall conform to our standard. (Refer to P20.)

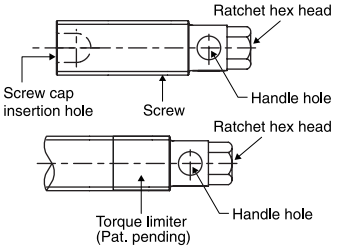
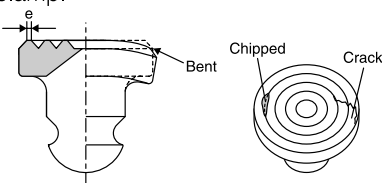
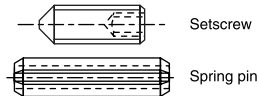
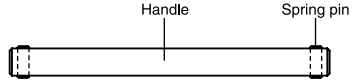
Inspection point	Item	Inspection procedure	Judgment criteria
② Screw (screw with torque limiter)	<ul style="list-style-type: none"> ● Bending ● Deformation ● Dents ● Cracks ● Screw cap 	<ul style="list-style-type: none"> ● Check the screw and the screw cap insertion hole for bending, deformation, dents and cracks, visually and if necessary by disassembling the clamp.  <p>Using a torque wrench, check to see if the tightening torque is the specified value. ※If you are unclear about anything, please contact our sales office.</p>	<ul style="list-style-type: none"> ● Do not use a screw that is bent, deformed, dented or cracked. <p>If the tightening torque is insufficient, remove the head and tighten up the bolt inside by 1/4 to 1/2 a turn.</p>
③ Screw cap and cam	<ul style="list-style-type: none"> ● Wear ● Cracks ● Deformation ● Chipping 	<p>Check for wear, cracks, deformation and chipping, visually and if necessary by disassembling the clamp.</p> 	<ul style="list-style-type: none"> ● Do not use a screw cap or cam that is worn, cracked, deformed or chipped. ● Wear width e $0.5 - 1 t$ $e \leq 0.3 \text{ mm}$ $2 - 5 t$ $e \leq 0.5 \text{ mm}$
④ Screw cap and cam	<ul style="list-style-type: none"> ● Loose or dropped out screw ● Spring pin ● Deformation ● Bending ● Wear ● Scuffing ● Looseness or dropout 	<ul style="list-style-type: none"> ● Check the screw for looseness or dropout, visually and if necessary by disassembling the clamp. ● Check each spring pin for deformation, bending, wear, scuffing, looseness and dropout, visually and if necessary by disassembling the clamp. 	<ul style="list-style-type: none"> ● If the setscrew is loose, tighten it up. If it has dropped out, insert a new screw. ● Do not use a setscrew that is deformed, bent, worn, scuffed or loose.
⑤ Handle	<ul style="list-style-type: none"> ● Bending ● Damage or dropped-out spring pin 	<ul style="list-style-type: none"> ● Visually check the handle for bending. ● Visually check the spring pin for scuffing or dropout (Strike the handle gently with a hammer to see if the spring pin is missing). 	<ul style="list-style-type: none"> ● Do not use a handle that is scuffed or one from which the spring pin has dropped out. ● Replace a handle that has a loose spring pin with a new one.

9. In-house Standard

1. Width of Opening

Model	Standard value (mm)	Allowable value (mm)
WF-0.5	41	41.9
WF-1	53.5	54.6
WF-2	60	61.2
WF-3	65.5	66.8
WF-5	71	72.4

DO NOT use a clamp if the width of the opening is greater than the allowable value.

2. Suspension Holes

2-1 Diametrical Deformation and Elongation of the Suspension Holes

Model	Suspension holes	Standard value (mm)	Allowable value (mm)
WF-0.5	A	25	25.8
	B	25	25.8
WF-1	A	30	30.9
	B	30	30.9
WF-2	A	34	35.0
	B	35	36.0
WF-3	A	35	36.0
	B	42	43.2
WF-5	A	40	41.2
	B	46	47.3

DO NOT use a clamp if the diameter of either of the suspension holes is greater than the allowable value.

2-2 Wear of the Suspension Holes

DO NOT use a clamp if the C part of either of the suspension holes exceeds 0.8 mm.

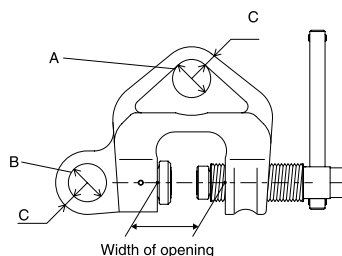



EC declaration of conformity

in compliance with the EC Machinery Directive 2006/42/EC, Annex II A

We hereby confirm that due to its design and construction and in the type marketed by us the machine designated below conforms with the pertinent essential safety and health requirements of the relevant EC Directive.

In case of a modification of the machine which is not agreed with us, this declaration is no longer valid.

Designation of the machine : screw clamp

Types : WF-0.5
WF-1
WF-2
WF-3
WF-5

Pertinent EC Directives : EC Machinery Directive (2006/42/EC)

Date/signature of manufacturer : 16.5.2011

Information on the signer : *T. Uryu*

(T.URYU)
Quality Assurance Division

The goods has passed rigid inspection by us ahead of delivery in accordance with our standard in terms of test load and all other respects in good and satisfactory condition.



ELEPHANT CHAIN BLOCK CO.,LTD.

**180 Iwamuro 2-chome, Osaka-Sayama-City,
Osaka, Postal code 589-8502, JAPAN
Phone : 072-365-7778 Fax : 072-365-7869**